

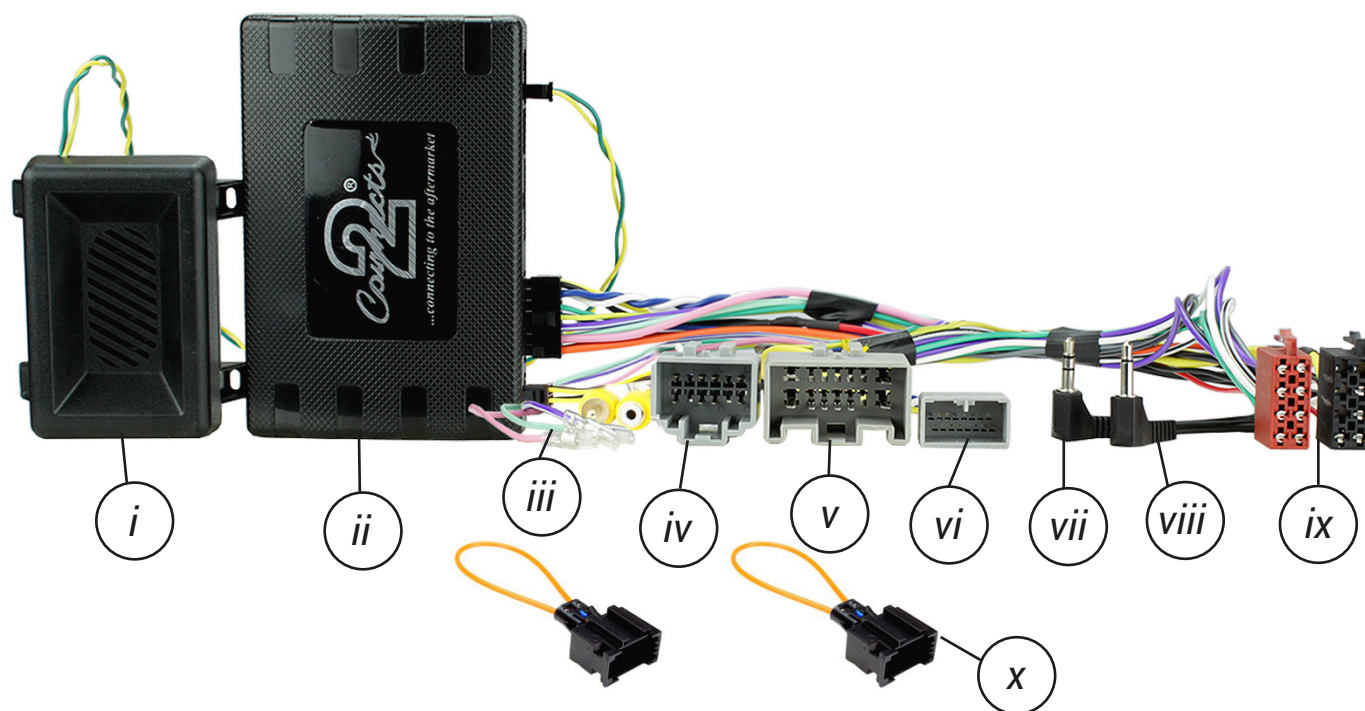

CTUVL01

Infodapter Interface for Volvo Vehicles



- i. Speaker Module
- ii. Interface Box
- iii. Flying Wires/Yellow RCA (Camera)
- iv. Volvo Speaker Connection
- v. Vehicle Specific Power Connection
- vi. CAN Data Connector
- vii. OEM 3.5mm Aux Retention
- viii. OEM 3.5mm Mic Retention
- ix. ISO Connector (16 Pin)
- x. MOST Loops (x2)

Designed and
Engineered
in the UK. 

APPLICATION

Note: Application data is subject to change at any time

Volvo V70	2007 - 2016
Volvo XC70	2007 - 2016

For non-amplified vehicles.

FEATURES

- Retains Steering Wheel Control Functionality
- Retains Phone Button Functionality
- Retains Microphone and AUX Inputs
- Retains Reversing Camera
- Generates Parking Sensor Audio and OEM Parking Sensor Graphics
- Provides Outputs for Park Brake, Reverse Gear & Speed Pulse
- Updateable via USB (contact supplier for more information)

DISCLAIMER

The information provided in this document is subject to change without notice due to manufacturer changes and/or improvements to the product/s. This instruction manual is based on documented data and research. The manufacturer of this product cannot be held responsible for any changes made to the vehicle by the manufacturer or damages that may occur through the installation of this product in accordance with the steps outlined herein.

PRODUCT INFORMATION

CTUVL01

The Infodapter interface aids the installation of an aftermarket head unit into an OEM dashboard. It helps retain steering wheel control presets as well as retaining vital features and functions which include the reverse camera and parking sensors (*if applicable*).

Note: *This product is for non-amplified vehicles only.*

WIRING KEY

IN ISO CONNECTOR

Purple	Right Rear Speaker +	Yellow	Permanent 12V
Purple/Black	Right Rear Speaker -	Black	Ground
Green	Left Rear Speaker +	Red	Ignition 12V
Green/Black	Left Rear Speaker -	Orange	Illumination
Grey	Right Front Speaker +		
Grey/Black	Right Front Speaker -		
White	Left Front Speaker +		
White/Black	Left Front Speaker -		

ADDITIONAL CONNECTIONS

Pink	Speed Pulse	Yellow RCA	Reverse Camera
Green	Park Brake	3.5mm (AUX)	Aux Retention
Purple/White	Reverse Gear	3.5mm (MIC)	Microphone Retention

INTERFACE CONNECTIONS

- ① Reverse Camera Extension Harness Input
- ② Power Harness Input
- ③ Head Unit Connection (Patch) Lead Input
- ④ DIP Switch 1 - 'ON' for Pioneer, 'OFF' for other brand head units
DIP Switch 2 - 'ON' for PAL reversing camera, 'OFF' for NTSC reversing camera (Default is 'OFF'/NTSC)
DIP Switch 3 - Change from 'OFF' to 'ON' and back to reset screen settings to factory defaults.
Note: *During this procedure, the screen background will change to red and no settings adjustments can be made.*
DIP Switch 4 - Not Used
- ⑤ Not used

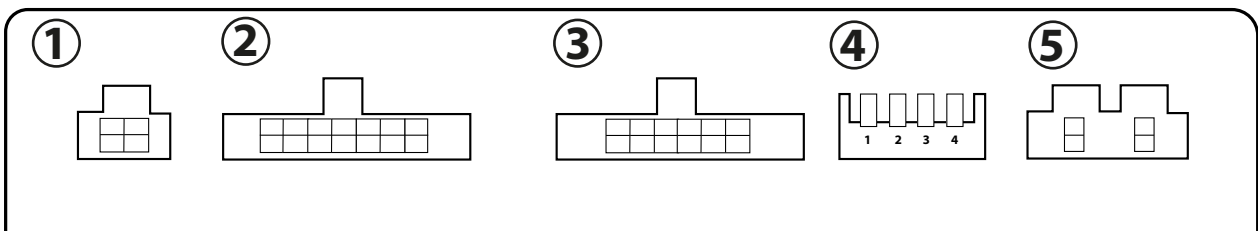

PRIOR TO INSTALLATION

Read the manual prior to installation. Technical knowledge is necessary for installation. The place of installation must be free of moisture and away from heat sources. Please ensure that the correct tools are used during the installation to avoid damage to the vehicle or product.

Connects2 can not be held responsible for the installation of this product.

INSTALLATION GUIDE

See Wiring Diagram on Pg.6 for more information

Before installing the interface, the factory stereo must be removed and disconnected. To do this, please consult the vehicle owner's manual/handbook or contact a fitting professional.

A stereo connection (patch) lead is also required for the installation of this interface (supplied separately). Please ensure that you have the correct lead before proceeding. For universal patch leads, prepare the wiring loops in accordance with the instruction manual supplied with the product before installation.

1. Connect the 12 Pin connector from the stereo connection (patch) lead to the interface box
2. Connect the opposite end of the stereo connection (patch) lead to the steering wheel control input on the back of the aftermarket stereo

NOTE: This may be a 3.5mm jack connector or a wired input depending on the brand of aftermarket stereo being fitted. Please consult the aftermarket stereo installation manual for further information on where to make the connection

**! IMPORTANT: THIS STEP MUST BE COMPLETED BEFORE CONNECTING POWER TO THE INTERFACE.
FAILURE TO DO SO MAY RESULT IN A LACK OF FUNCTIONALITY AND THE NEED TO REINSTALL THE PRODUCT**

3. Connect the 14 Pin connector from the supplied wiring loom + 2-pin speaker wire to the interface box
4. Connect 4 Pin camera extension harness to the interface box
5. Connect the power/speaker ISO connector to the power/speaker ISO connector at the rear of aftermarket stereo

Note: For aftermarket stereos which do not have an ISO connector, please see 'Wiring Key' on Pg.2 for information on which wires to connect. Some interfaces may also have additional 'flying' wires which can be connected to the vehicle to support various features i.e. parking brake trigger, reverse gear and speed pulse. Details of these can be found under 'Additional Connections'.

6. Connect additional flying wires from the main wiring harness to the head unit as required

Note: the Reverse Gear wire must be connected for the interface to function correctly.

7. Connect the 2x MOST loop connectors that come with the kit to vehicle's OEM fibre connections located behind the head unit and the button panel.
8. Connect the 3.5mm jack connectors to the back of the aftermarket head unit to retain the vehicle's OEM Aux input and Microphone
9. Connect the CAN Data connector to the vehicles OEM connector
10. Connect male yellow RCA from the camera extension harness to the reverse camera input of the aftermarket head unit.
11. Connect the vehicle specific power connector on the supplied harness to the OEM connector from the vehicle
12. Test stereo and steering wheel control functionality for correct operation before reassembling the vehicle dashboard. If steering wheel control functions are unresponsive, please uninstall the interface and wiring and reinstall carefully in accordance with the above steps.

***For further help, please contact and fill out a support ticket with the full details of your issue at:
support.connects2.com/tickets/technical***

USER GUIDE

STEERING WHEEL CONTROL FUNCTIONALITY

The following diagram, though based on careful research, is an example only. Individual steering wheel control configurations may differ.

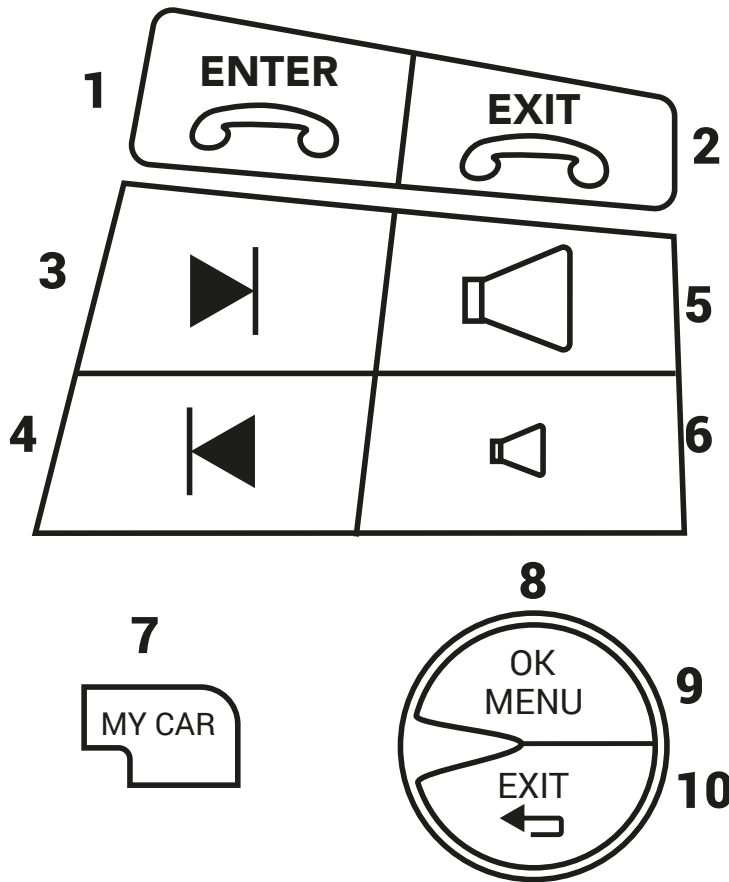

In Normal Mode

1. Pick Up (where vehicle doesn't allow use *fig.9*)
2. Hang Up (where vehicle doesn't allow use *fig.10*)
3. Track Forward
4. Track Back
5. Volume Up
6. Volume Down
7. **Enter Infodapter Menu**

In Infodapter Mode

8. Navigate options up/down (*use rotation*)
9. Select Menu Item
10. **Back/Exit Infodapter Menu**

INFODAPTER MENU

IMPORTANT: When installation is complete and you first power on the vehicle, you **MUST** go through and select the appropriate options to ensure the OEM setting memory is able to communicate properly.

Pressing the **MY CAR** Button (*fig 7*) located on the OEM button panel will access the 'Configuration Menu'. The Infodapters 'Configuration menu' showcases a series of options and settings that can be altered to tailor the user's experience:

MY CAR

The 'My Car' menu contains all of the original vehicle settings. All vehicle setup options that were available with the original head unit are now available through the aftermarket head unit.

See the vehicle handbook for more information regarding these features.

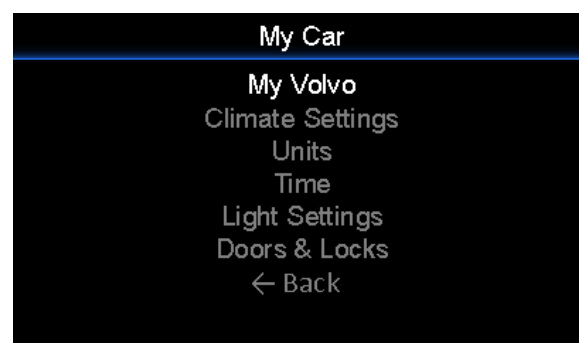
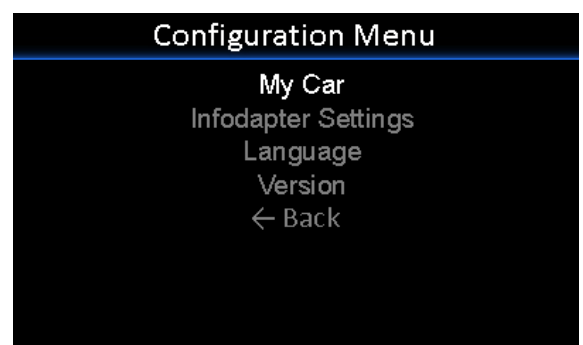

INFODAPTER MENU

INFODAPTER SETTINGS

The 'Infodapter Settings' menu contains parameters that can be selected to enhance/adapt the Infodapters layout and functionality.

SCREEN SIZE/POSITION

Allows the user to setup the Infodapter display screen to the exact size of the aftermarket head unit being fitted.

PICTURE SETTINGS

Allows the user to adjust the Brightness, Contrast and Saturation levels of the Infodapter menus/parking graphics.

PREFERENCES

• **Camera Connected**

Select 'Yes' if an optional camera is connected

• **Reverse Priority**

Select which image (Camera or Park Assist) will be shown by default when reversing.

(Note: this option is only available when Camera Connected is set to 'Yes')

• **Park Assist Version**

Select according to the colour configuration of the park assist fitted to the vehicle.

• **Park Brake Source**

Set Park Brake output to activate when park brake is on (**Brake**), when speed is less than 3km/h (**Speed**) or to remain on at all times (**Always On**)

• **Restore Factory Settings**

Select Yes to return all Infodapter settings to factory defaults

LANGUAGE & VERSION

The latter of the settings menu gives the user a selection of languages - English/French/German/etc. - as well as the ability of viewing the current version history.

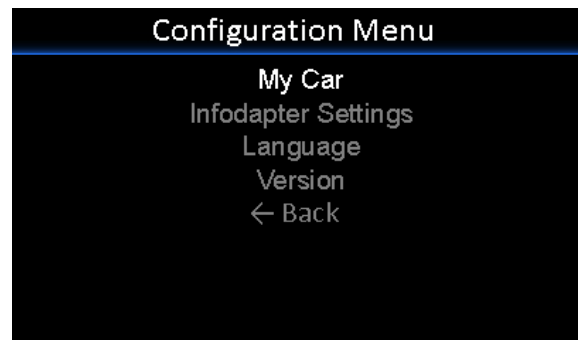
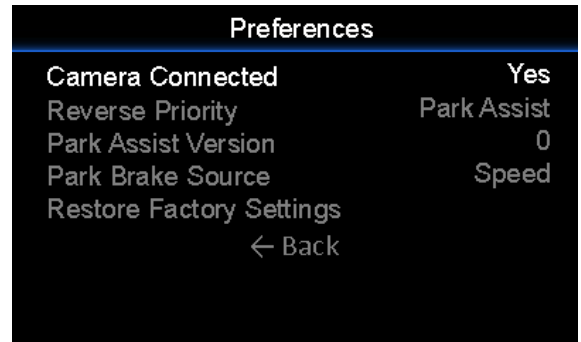
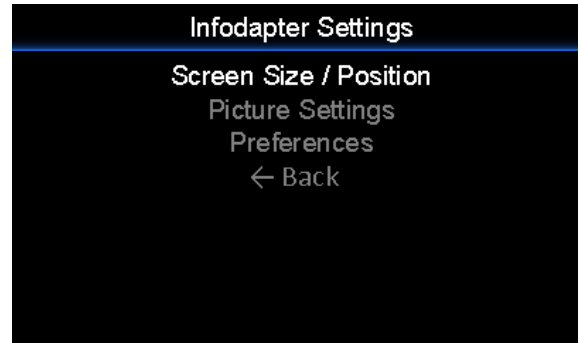

WIRING DIAGRAM

Flying Wires

Pink - Speed Pulse

Green - Park Brake

Purple/White - Reverse Gear

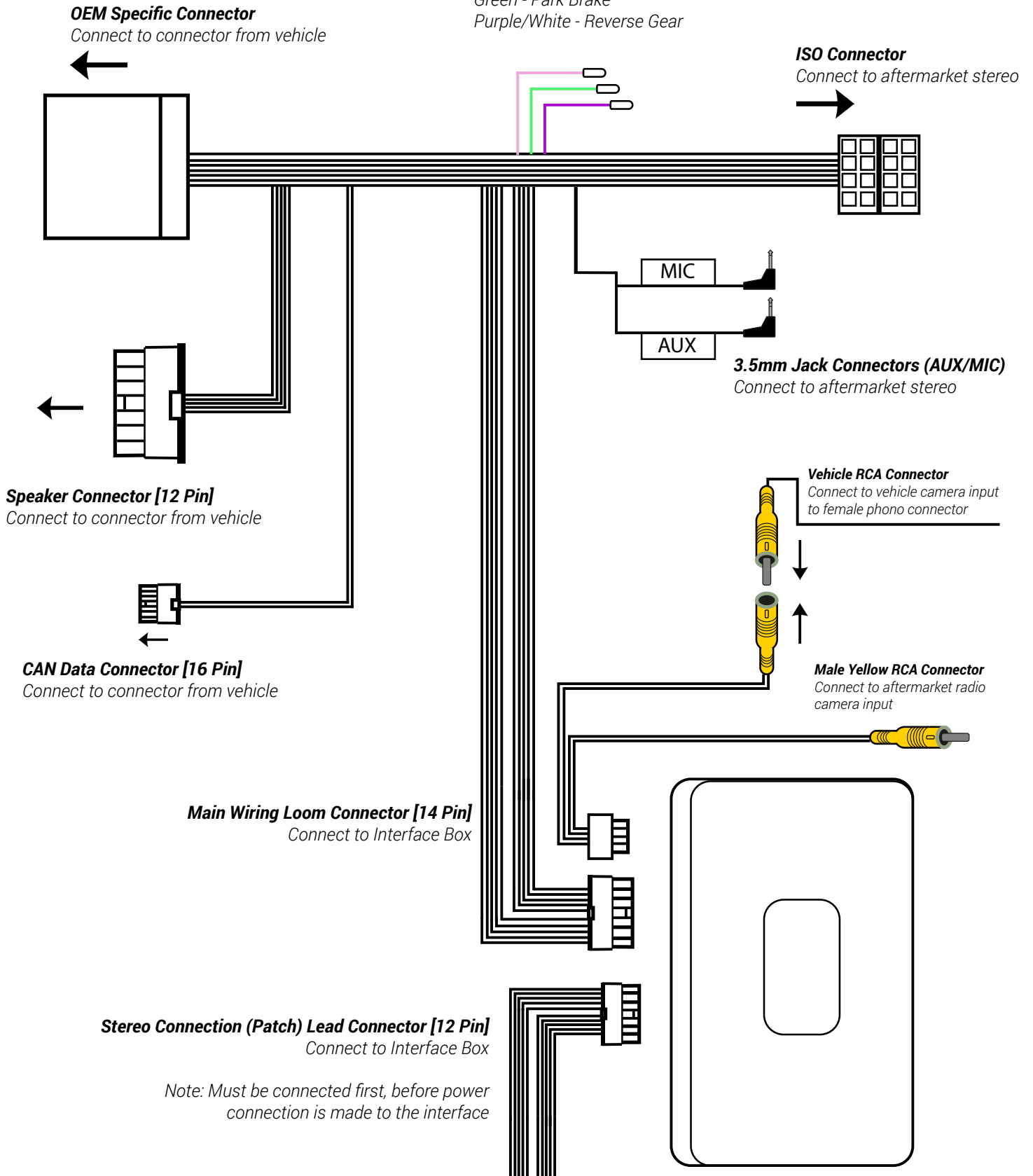

Need help? Visit support.connects2.com/tickets/technical